

Made of corrosion-resistant materials

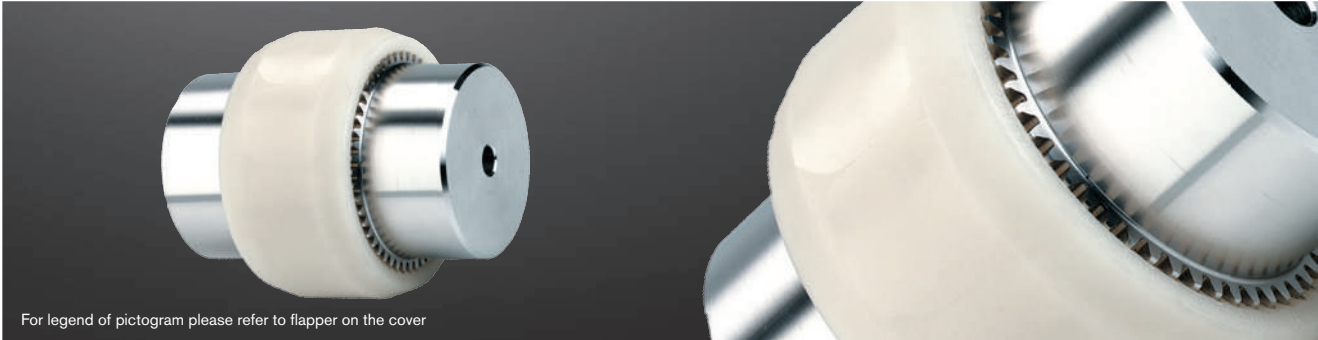

For legend of pictogram please refer to flapper on the cover



BoWex® junior plug-in coupling (two-part) and BoWex® junior M (three-part)

Size	Finish bore				Dimensions [mm]									
	Hub Component 1b		Plug-in sleeve Component 2b		D _H	l ₁ , l ₂	E ₁	E	L _{H1}	L _H	L ₁	L	M ₁	M, N
	d ₁	D ₁	d ₂	D ₂										
14 M-14	Ø6, Ø7, Ø8, Ø9	22	Ø8	22	40	23	2	4	40	37	48	50	8	6.5
	Ø10, Ø11	25	Ø10, Ø11	25										
	Ø12, Ø14	26	Ø12, Ø14	26										
19 M-19	Ø12, Ø14	27	Ø14, Ø15	29	48	25	2	4	42	37	52	54	10	8.5
	Ø16	30												
	Ø19	32												
24 M-24	Ø10, Ø11, Ø12	26	Ø14, Ø16	32	53	26	2	4	45	41	54	56	9	7.5
	Ø14, Ø15, Ø16	32												
	Ø18, Ø19, Ø20	36												
	Ø24	38	Ø24	40										

BoWex® Type M

Size	Finish bore d ₁ max. · d ₂ max.	Dimensions [mm]						
		D _H	D	l ₁ , l ₂	E	L _H	L	M, N
M-24	24	53	36	26	4	41	56	7.5
M-38	38	83	58	40	4	48	84	18
M-48	48	95	68	50	4	50	104	27

Other coupling sizes: M-24C, M-38C, M-48C on request. Setscrews with BoWex® junior coupling are made of V4A as a standard. For performance data see page 88.

Applications:

Food industry, print and paper industry, textile industry, sewage technology, wash-mobiles, chemical and pharmaceutical industry, offshore units, etc. For use in aggressive environment (air, water, chemicals, etc.).

Ordering example:	BoWex® M-24 V4A	d ₁ Ø20	d ₂ Ø24
	Size and type of coupling	Finish bore H7 keyway to DIN 6885 sheet 1 (JS9)	Finish bore H7 keyway to DIN 6885 sheet 1 (JS9)

Any questions? Please contact us.

Type junior plug-in coupling (two-part)

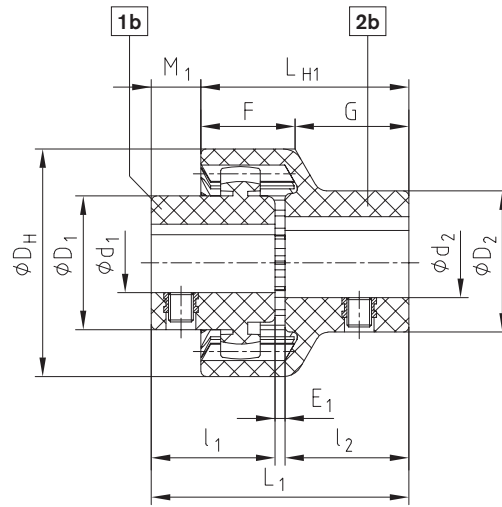

BoWex®

Type junior M coupling (three-part)

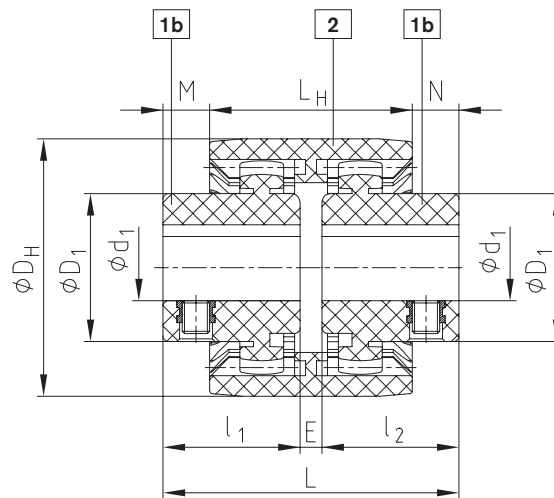

Type M (V4A)

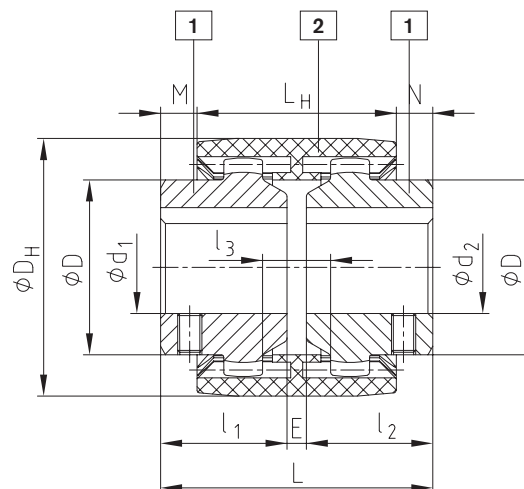

GEARex®

Technical data

Power, torque and speed							
Type and size		Power P [kW] / n [rpm]		Torque [Nm]			Max. speed [rpm]
		Rated	Max.	T _{KN}	T _{K max}	T _{KW}	
Type plug-in coupling/ junior M	junior 14 / M-14	0.0005	0.010	5	10	2.5	6000
	junior 19 / M-19	0.0008	0.0017	8	16	4	6000
	junior 24 / M-24	0.0013	0.0025	12	24	6	6000
Type M AS Spec.-I SG SSR	14	0.0010	0.003	10	30	5	14000
	19	0.0017	0.005	16	48	8	11800
	24	0.0021	0.006	20	60	10	10600
	28	0.0047	0.014	45	135	23	8500
	32	0.0063	0.019	60	180	30	7500
	38	0.0084	0.025	80	240	40	6700
	42	0.010	0.031	100	300	50	6000
	45 / 48	0.015	0.044	140	420	70	5600
	65	0.040	0.119	380	1140	190	4000
	80	0.073	0.22	700	2100	350	3150
	100	0.13	0.38	1200	3600	600	3000
	125	0.26	0.78	2500	7500	1250	2120
Type M...C GT	14	0.0015	0.0047	15	45	7.5	14000
	19	0.0025	0.0075	24	72	12	11800
	24	0.003	0.009	30	90	15	10600
	28	0.007	0.022	70	210	35	8500
	32	0.009	0.028	90	270	45	7500
	38	0.013	0.038	120	360	60	6700
	48	0.021	0.063	200	600	100	5600
	65	0.058	0.18	560	1680	280	4000
Type HEW Compact	T50 Sh	0.0236	0.0471	200	400	50	7300
	42-130 T65 Sh	0.0283	0.0565	270	540	68	7300
	T70 Sh	0.0330	0.0660	320	640	80	7300
	T50 Sh	0.0628	0.1257	550	1100	138	5500
	65-180 T65 Sh	0.0785	0.1571	740	1500	185	5500
	T70 Sh	0.0890	0.1780	860	1700	215	5500
	T50 Sh	0.1414	0.2827	1250	2500	313	4400
	80-225 T65 Sh	0.1728	0.3455	1600	3200	400	4400
	T70 Sh	0.2042	0.4084	1900	3800	475	4400
	T50 Sh	0.3141	0.6283	2750	5500	688	3200
	100-305 T65 Sh	0.4084	0.8168	3900	7800	975	3200
	T70 Sh	0.4712	0.9424	4500	9000	1125	3200
	T50 Sh	0.6283	1.2565	5500	11000	1375	2900
	125-365 T65 Sh	0.7853	1.5707	7500	15000	1875	2900
	T70 Sh	0.8901	1.7801	8400	16800	2100	2900

Thread for setscrews

Thread dimensions for setscrews, BoWex® coupling hubs with cylindrical bore.

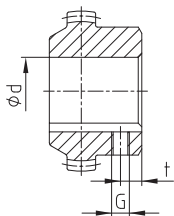

Position of the thread for setscrews BoWex® M-14 to M-24 opposite the keyway

BoWex® M-28 to I-125 on the keyway

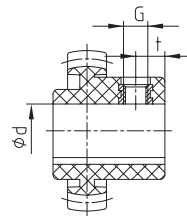

Position of thread with BoWex® junior plug-in coupling and junior M coupling

BoWex® coupling hubs							
Size Dimensions	14 19 24	28 32 38	42 45 48	65	80	100	125
Thread G	M5	M8	M10	M10	M12	M16	
Distance t	6	10	15 ¹⁾ 20	20	30	40	
Tightening torque T _A [Nm]	2	10	17	17	40	80	

BoWex® junior coupling hubs			
Size Dimensions	14	19	24
Thread G	M5	M5	M5
Hub 1b - Distance t	6	6	6
Plug-in sleeve 2b - Distance t	8	10	10
Tightening torque T _A [Nm]	1.4	1.4	1.4

¹⁾ Length of hub 55 mm t = 15 mm, 70 mm t = 20 mm

Types of hubs

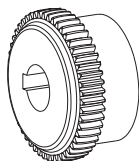

Type 1.0 hub with feather keyway and setscrew

Positive-locking power transmission, permissible torque depending on the permissible surface pressure. Not suitable for backlash-free power transmission with heavily reversing operation.

Type 1.1 hub without feather key with setscrew

Non-positive torque transmission for crimp connections and adhesive bonds. (No ATEX approval)

Type 1.3 hub with spline bore (see page 107)

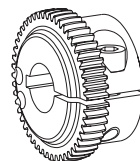

Type 2.0 clamping hub single slot without feather keyway

Frictionally engaged, backlash-free shaft-hub-connection. Transmittable torques depending on bore diameter.

Type 2.1 clamping hub single slot with feather keyway

Positive-locking power transmission with additional friction fit. The friction fit avoids or reduces reverse backlash. Surface pressure of the keyway connection is reduced.

Type 2.3 clamping hub with spline bore (see page 107)

Displacements

BoWex® couplings are double-cardanic compensating for axial, radial and angular shaft displacements in addition to transmitting the torque so that damage on the driving or driven machine is prevented.

Axial displacement

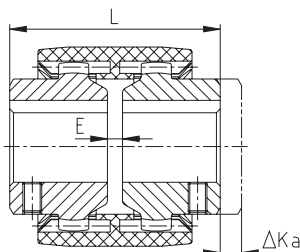

Radial displacement

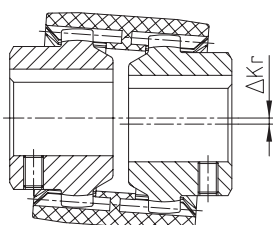

Angular displacement

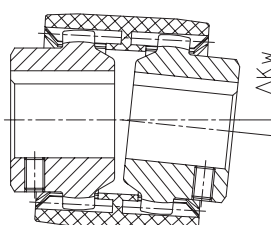

Radial and angular displacement

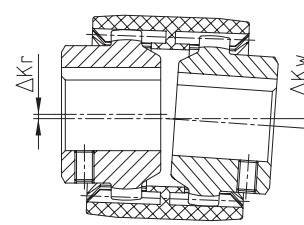

Displacements – type junior couplings

BoWex® size	Type junior plug-in coupling			Type junior M		
	14	19	24	14	19	24
Max. axial displacement ΔK_a [mm]	± 1	± 1	± 1	± 1	± 1	± 1
Max. radial displacement with $n=1500$ rpm ΔK_r [mm]	± 0.1	± 0.1	± 0.1	± 0.3	± 0.3	± 0.4
Max. radial displacement with $n=3000$ rpm ΔK_r [mm]	± 0.1	± 0.1	± 0.1	± 0.3	± 0.3	± 0.4
Max. angular displacement with $n=1500$ rpm ΔK_w [degree]	± 1.0	± 1.0	± 0.9	± 1.0	± 1.0	± 0.9
Max. angular displacement with $n=3000$ rpm ΔK_w [degree]	± 0.7	± 0.7	± 0.6	± 0.7	± 0.7	± 0.6

Displacements – type M, I, AS, Spec.-I, SG and SSR

BoWex® size	14	19	24	28	32	38	42	48	65	80	100	125
Max. axial displacement ΔK_a [mm]	± 1	± 1	± 1	± 1	± 1	± 1	± 1	± 1	± 1	± 1	± 1	± 1
Max. radial displacement with $n=1500$ rpm ΔK_r [mm]	± 0.30	± 0.30	± 0.35	± 0.35	± 0.35	± 0.40	± 0.40	± 0.40	± 0.45	± 0.45	± 0.45	± 0.45
Max. radial displacement with $n=3000$ rpm ΔK_r [mm]	± 0.20	± 0.20	± 0.23	± 0.23	± 0.23	± 0.25	± 0.25	± 0.25	± 0.28	± 0.28	± 0.28	± 0.28
Max. angular displacement with $n=1500$ rpm ΔK_w [degree]	± 1.0	± 1.0	± 0.9	± 0.9	± 0.9	± 0.9	± 0.9	± 0.9	± 0.7	± 0.6	± 0.6	± 0.4
Max. angular displacement with $n=3000$ rpm ΔK_w [degree]	± 0.7	± 0.7	± 0.6	± 0.6	± 0.6	± 0.6	± 0.6	± 0.6	± 0.5	± 0.4	± 0.4	± 0.3

Displacements – Type GT

Displacements – Type HEW Compact

BoWex® size	Displacements – Type GT				Displacements – Type HEW Compact																
	28	38	48	65	42-130			65-180			80-225			100-305			125-365				
					T50	T65	T70	T50	T65	T70	T50	T65	T70	T50	T65	T70	T40	T52	T65		
Max. axial displacement ΔK_a [mm]	± 1	± 1	± 1	± 1	± 2			± 2			± 2			± 2			± 2				
Max. radial displacement with $n=1500$ rpm ΔK_r [mm]	± 1	± 1	± 1.4	± 1.4	± 1.1	± 1	± 0.5	± 1.6	± 1.5	± 0.7	± 1.8	± 1.7	± 2.2	± 2.2	± 2	± 2	± 1	± 2.5	± 2.3	± 1.1	
Max. radial displacement with $n=3000$ rpm ΔK_r [mm]	± 0.6	± 0.6	± 1	± 1	± 0.55	± 0.5	± 0.25	± 0.8	± 0.75	± 0.35	± 0.9	± 0.85	± 1.1	± 1.1	± 1	± 1	± 0.5	± 1.25	± 1.15	± 0.55	
Max. angular displacement with $n=1500$ rpm ΔK_w [degree]	± 1	± 1	± 0.9	± 0.9	± 1	± 0.75	± 0.5	± 1	± 0.75	± 0.5	± 1	± 0.75	± 1	± 1	± 1	± 1	± 0.75	± 0.5	± 1	± 0.75	± 0.5
Max. angular displacement with $n=3000$ rpm ΔK_w [degree]	± 0.7	± 0.7	± 0.6	± 0.6	± 0.5	± 0.4	± 0.25	± 0.5	± 0.4	± 0.25	± 0.5	± 0.4	± 0.25	± 0.5	± 0.25	± 0.25	± 0.5	± 0.25	± 0.5	± 0.4	± 0.25

The permissible displacement figures of the BoWex® couplings specified are general standard values taking into account the load of the coupling up to the rated torque T_{KN} of the coupling. With different operating conditions please order our data sheet for displacements of BoWex® KTR-N 20140. The displacement figures may only be used one by one, if they appear simultaneously, they must be limited in proportion. Care should be taken to maintain the distance dimension E accurately in order to allow for axial clearance of the coupling while in operation. Detailed mounting instructions are shown on our homepage www.ktr.com.

Cylindrical bores, taper/inch bores see selection of standard IEC motors

Stock programme of cylindrical finish bores [mm] H7 feather keyway acc. to DIN 6885 sheet 1 [JS9] and thread for setscrews																														
BoWex® Size	un/pilot bored	Ø8	Ø10	Ø11	Ø12	Ø14	Ø15	Ø16	Ø17	Ø18	Ø19	Ø20	Ø22	Ø24	Ø25	Ø28	Ø30	Ø32	Ø35	Ø38	Ø40	Ø42	Ø45	Ø48	Ø50	Ø55	Ø60	Ø65	Ø70	Ø75
14	●■	●	●	●	●	●	●																							
19	●■		●	●	●	●	●	●	●	●	●■	●																		
24	●■		●	●	●	●■	●	●	●	●	●■	●■	●	●■	●															
28	●■				●	●	●	●	●	●	●	●	●	●	●	●■														
32	●■							●		●	●	●	●	●	●	●	●	●	●											
38	●■							●		●	●	●	●	●	●	●	●	●	●	●■										
42	●■									●	●	●	●	●	●	●	●	●	●	●	●	●	●	●	●					
48	●■										●				●	●	●	●	●	●	●	●	●■	●■	●■					
65	●■																●■	●	●■	●	●■	●■	●■	●■	●■	●■	●■	●■	●■	●■
80	●																						●		●	●	●	●	●	

● Standard length ■ Standard lengthened

Stock programme taper and inch bores																				
Code d +0.05 b JS9 t +0.2	Taper 1:5					Taper 1:8					Inch bores									
	A-10 9.85 2	B-17 16.85 3	C-20 19.85 4	D-25 24.85 5	E-30 29.85 6	N/1 9.7 2.4	N1d 14 3	N/2 17.28 3.2	N/2a 17.28 4	N/3 22 3.99	Ta 12.7 3.17 14.3	DNC 13.45 3.17 14.9	Ed 15.87 4.75 18.1	A 19.05 4.78 21.3	G 22.22 4.75 24.7	F 22.22 6.38 25.2	Bs 25.38 6.37 28.3	Hs 25.4 6.35 28.7	K 31.75 7.93 35.4	
14	●						●												●	
19		●					●						●						●	
24	●	●					●		●	●		●		●					●	●
28	●	●					●	●	●	●		●		●					●	
32		●																		●
38		●							●	●				●						
42		●		●					●	●		●		●			●			
48																				
65																				●

Other dimensions on request.

BoWex® couplings for standard IEC motors, protection class IP 54/IP 55										
A. C. motor Size	Motor power with 50 Hz n = 3000 [rpm]			Motor power with 50 Hz n = 1500 [rpm]			Motor power with 50 Hz n = 1000 [rpm]			Cylindrical shaft ends d x l [mm] 3000 ≤ 1500
	kW	T [Nm]	BoWex® coupling	kW	T [Nm]	BoWex® coupling	kW	T [Nm]	BoWex® coupling	
56	0.09	0.32		0.06	0.43		0.037	0.43		9 x 20
	0.12	0.41		0.09	0.64		0.045	0.52		
63	0.18	0.62	14	0.12	0.88	14	0.06	0.72	14	11 x 23
	0.25	0.86		0.18	1.3		0.09	1.1		
71	0.37	1.3	19	0.25	1.8	19	0.18	2.0	19	14 x 30
	0.55	1.9		0.37	2.5		0.25	2.7		
80	0.75	2.5	24	0.55	3.7	24	0.37	3.9	24	19 x 40
	1.1	3.7		0.75	5.1		0.55	5.8		
90 S	1.5	5.0	28	1.1	7.5	28	0.75	8.0	28	24 x 50
90 L	2.2	7.4		1.5	10		1.1	12		
100 L	3	9.8	38	2.2	15	38	1.5	15	38	28 x 60
				3	20		2	22		
112 M	4	13	42	4	27	42	2.2	22	42	38 x 80
132 S	5.5	18		5.5	36		3	30		
	132 M	7.5	25	7.5	49	4	40	5.5	55	
160 M	11	36	48	11	72	48	7.5	75	48	42 x 110
	15	49		15	98		11	108		
160 L	18.5	60	80	18.5	121	80	15	148	80	48 x 110
180 M	22	71		22	144		15	148		
180 L			100			100	18.5	181	100	55 x 110
200 L	30	97		30	196		22	215		
225 S			125	37	240	125			125	55 x 110 60 x 140
225 M	45	145		45	292		30	293		
250 M	55	177	150	55	356	150	37	361	150	60 x 140 65 x 140
280 S	75	241		75	484		45	438		
280 M	90	289	175	90	581	175	55	535	175	75 x 140
315 S	110	353		110	707		75	727		
315 M	132	423	200	132	849	200	90	873	200	80 x 170
	160	513		160	1030		110	1070		
315 L	200	641	250	200	1290	250	132	1280	250	65 x 140
				160	1550		160	1550		
315	250	801	315	250	1610	315	200	1930	315	85 x 170
	315	1010		315	2020		250	2420		
355	355	1140	400	355	2280	400	315	3040	400	75 x 140 95 x 170
	400	1280		400	2560					

Torque T ^Δ = rated torque according to Siemens catalogue.

Taper bores

BoWex® with taper bore

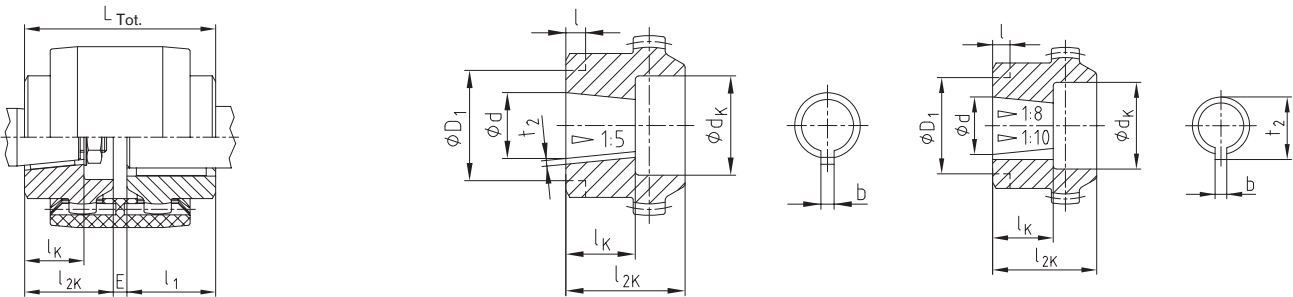

$L_{Tot} = l_1 + E + l_{2K}$

see stock programme on page 90

Taper bores 1:5

Dimensions [mm]					Counterbore d _K and hub length l _{2K} [mm] Recess on hub collar D ₁ x l [mm]																		
Code	Details of bores				14		19		24		28		32		38		42		48		65		
	d +0.05	b ^{JS9}	t ₂ +0.1	l _K	d _K	l _{2K}	d _K	l _{2K}	d _K	l _{2K}	d _K	l _{2K}	d _K	l _{2K}	d _K	l _{2K}	d _K	l _{2K}	d _K	l _{2K}	d _K	l _{2K}	
A-10	9.85	2	1.0	11.5	18	23	18	25	25	26	25	26	25	26	25	26							
B-17	16.85	3	1.8	18.5			30 x 7	30	30	36	40	36	40	36	40	36	40	45	42	45	42	45	50
C-20	19.85	4	2.2	21.5					28	36	36	40	36	40	36	40	45	42	45	42	45	50	
Cs-22	21.95	3	1.8	21.5					28	36	36	40	36	40	36	40	45	42	45	42			
D-25	24.85	5	2.9	26.5							36	40	36	40	36	40	45	42	45	42	45	50	
E-30	29.85	6	2.6	31.5									36	40	45	55	45	55	45	55	45	55	
F-35	34.85	6	2.6	36.5															52	60	55	60	
G-40	39.85	6	2.6	41.5															52	60	65	70	

Taper bores 1:8

Dimensions [mm]					Counterbore d _K and hub length l _{2K} [mm] Recess on hub collar D ₁ x l [mm]																	
Code	Details of bores				14		19		24		28		32		38		42		48		65	
	d +0.05	b ^{JS9}	t ₂ +0.1	l _K	d _K	l _{2K}	d _K	l _{2K}	d _K	l _{2K}	d _K	l _{2K}	d _K	l _{2K}	d _K	l _{2K}	d _K	l _{2K}	d _K	l _{2K}	d _K	l _{2K}
N/1	9.7 ± 0.015	2.4 +0.05	10.85	17	18	26	18	25	25	26	25	30	25	30	25	30						
N/1c	11.6	3 ^{JS9}	12.90	16.5	18	23			25	26	25	30										
N/1e	13	2.4 +0.05	13.80	21					25	30	25	30			25	30						
N/1d	14	3 ^{JS9}	15.50	17.5	20	23	25	30	28	30	28	30	28	40								
N/2	17.287	3.2 +0.05	18.24	24					28	35	36	40	36	40	36	40	45	42	45	42	45	50
N/2a	17.287	4 ^{JS9}	18.94	24					28	35	36	40	36	40	36	40	45	42	45	42	45	50
N/2b	17.287	3 ^{JS9}	18.34	24					28	35					36	40	45	42	45	42		
N/3	22.002	4 ^{JS9}	23.40	28							36	40	36	40	36	40	45	42	45	42	45	50
N/4	25.463	4.78 +0.05	27.83	36							36	50	36	50	36	50	45	50	45	50	45	62
N/4b	25.463	5 ^{JS9}	28.23	36													58 x 10	58 x 10				
N/4a	27	4.78 +0.05	28.80	32.5							36	50			36	50						
N/4g	28.45	6 ^{JS9}	29.32	38.5											36	60	45	60	45	60		
N/5	33.176	6.38 +0.05	35.39	44											45	60	45	60	45	60	45	62
N/5a	33.176	7 ^{JS9}	35.39	44													45	60	45	60	45	62

Taper bores 1:10

Dimensions [mm]					Counterbore d _K and hub length l _{2K} [mm]																	
Code	Details of bores				14		19		24		28		32		38		42		48		65	
	d +0.05	b ^{JS9}	t ₂ +0.1	l _K	d _K	l _{2K}	d _K	l _{2K}	d _K	l _{2K}	d _K	l _{2K}	d _K	l _{2K}	d _K	l _{2K}	d _K	l _{2K}	d _K	l _{2K}	d _K	l _{2K}
CX-20	19.85	5	22.08	32							36	50			36	50	45	50	45	50		
DX-25	24.95	6	26.68	45									36	50			45	60	45	60	45	60
EX-30	29.75	8	31.88	50													45	60	45	60	45	70

Spline hubs and inch bores

BoWex® spline hubs – basic programme

Spline hub (N)

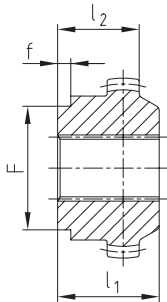

Clamping hub (K)

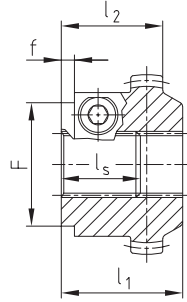

If it is not possible to fasten the hubs of pump shafts with involute spline by means of an end plate and a screw, we recommend to use our spline clamping hub.
Radial clamping ensures a backlash-free tight fit on the pump shaft.

Spline and clamping hubs to DIN 5480								
Size	Dimensions [mm]							Order designation specify coupling size
	Type	Spline size	l ₁	l ₂	l _S	F	f	
42	N	25x1.25x18	42	-	-	-	-	P000205
	K	25x1.25x18	42	-	-	-	-	P500202
48	K	30x2x14	42	-	-	60	6	P500203
	N	30x2x14	50	-	-	60	6	P000206
	K	30x2x14	50	-	-	60	6	P500203
65	N	35x2x16	55	-	-	60	6	P000303
	K	35x2x16	60	-	-	60	6	P500301
	N	40x2x18	55	-	-	78	6	P000304
	K	40x2x18	60	-	-	78	6	P500302
	K	45x2x21	55	-	-	78	6	P500401

Spline and clamping hubs to ANSI B92.1								
Size	Dimensions [mm]							Order designation specify coupling size
	Type	Spline size	l ₁	l ₂	l _S	F	f	
42	K	PH-S 5/8"	42	-	-	-	-	P558101
		16/32DP, z=9						
42	K	PI-S 3/4"	-	35	-	-	-	P559101
		16/32DP, z=11						
	K	PB-S 7/8"	42	-	-	60	3	P567101
		16/32DP, z=13						
48	K	PB-BS 1"	42	-	27	50	6	P660201
		16/32DP, z=15						
48	K	PA-S 3/8"	50	-	45	52	7	P663301
		16/32DP, z=21						
65	K	PA-S 3/8"	55	-	48	52	5	P663301
		16/32DP, z=21						
	K	PC-S 1 1/4"	55	-	44	52	5	P656201
		12/24DP, z=14						

Inch bores – see stock programme page 86											
Bore and keyway acc. to ANSI/AGMA 9002-C14 Bore (clearance fit) Keyway (commercial class fit)						Bore and keyway acc. to ANSI/AGMA 9002-C14 Bore (clearance fit) Keyway (commercial class fit)					
KTR Code	Bore Ø [Inch]	Width of keyway [Inch]	Bore Ø [mm]	Width of keyway [mm]	Keyway depth/Tolerance +0.381 [mm]	KTR Code	Bore Ø [Inch]	Width of keyway [Inch]	Bore Ø [mm]	Width of keyway [mm]	Keyway depth/Tolerance +0.381 [mm]
Tb	3/8	1/8	9.525 ^{+0.0254}	3.175 ^{+0.05}	10.972	Sd	1 1/8	5/16	28.575 ^{+0.0254}	7.937 ^{+0.051}	32.105
DNB	7/16	3/32	11.112 ^{+0.0254}	2.382 ^{+0.051}	12.293	Js	1 1/4	1/4	31.75 ^{+0.0254}	6.35 ^{+0.051}	34.721
T	1/2	3/16	12.7 ^{+0.0254}	4.762 ^{+0.051}	14.757	K	1 1/4	5/16	31.75 ^{+0.0254}	7.937 ^{+0.051}	35.331
Ta	1/2	1/8	12.7 ^{+0.0254}	3.175 ^{+0.051}	14.224	Ma	1 3/8	5/16	34.925 ^{+0.0254}	7.937 ^{+0.051}	38.557
DNC	17/32	1/8	13.495 ^{+0.0254}	3.175 ^{+0.051}	15.011	RH1	1 3/8	3/8	34.925 ^{+0.0254}	9.525 ^{+0.063}	39.141
Do	9/16	1/8	14.287 ^{+0.0254}	3.175 ^{+0.051}	15.824	Cb	1 7/16	3/8	36.512 ^{+0.0254}	9.525 ^{+0.063}	40.767
E	5/8	1/8	15.875 ^{+0.0254}	3.175 ^{+0.051}	17.424	Ca	1 1/2	5/16	38.1 ^{+0.0254}	7.937 ^{+0.051}	41.783
Es	5/8	5/32	15.875 ^{+0.0254}	3.968 ^{+0.051}	17.729	C	1 1/2	3/8	38.1 ^{+0.0254}	9.525 ^{+0.0635}	42.392
Ed	5/8	3/16	15.875 ^{+0.0254}	4.762 ^{+0.051}	18.008	Nb	1 5/8	3/8	41.275 ^{+0.0254}	9.525 ^{+0.0635}	45.618
DNH	11/16	3/16	17.462 ^{+0.0254}	4.762 ^{+0.051}	19.634	Ls	1 3/4	3/8	44.45 ^{+0.0254}	9.525 ^{+0.0635}	48.818
Ad	3/4	1/8	19.05 ^{+0.0254}	3.175 ^{+0.051}	20.624	L	1 3/4	7/16	44.45 ^{+0.0254}	11.112 ^{+0.0635}	49.428
A	3/4	3/16	19.05 ^{+0.0254}	4.762 ^{+0.051}	21.259	Lu	1 7/8	1/2	47.625 ^{+0.0254}	12.7 ^{+0.0635}	53.238
G	7/8	3/16	22.225 ^{+0.0254}	4.762 ^{+0.051}	24.485	Da	1 15/16	1/2	49.212 ^{+0.0254}	12.7 ^{+0.0635}	54.864
F	7/8	1/4	22.225 ^{+0.0254}	6.35 ^{+0.051}	25.069	Ds	2	1/2	50.8 ^{+0.0254}	12.7 ^{+0.0635}	56.464
Gf	15/16	1/4	23.812 ^{+0.0254}	6.35 ^{+0.051}	26.695	Pa	2 1/8	1/2	53.975 ^{+0.0381}	12.7 ^{+0.063}	59.69
H	1	3/16	25.4 ^{+0.0254}	4.762 ^{+0.051}	27.686	U	2 1/4	1/2	57.15 ^{+0.0381}	12.7 ^{+0.063}	62.915
Hs	1	1/4	25.4 ^{+0.0254}	6.35 ^{+0.051}	28.295	Ub	2 3/8	5/8	60.325 ^{+0.0381}	15.875 ^{+0.076}	67.335
R	1 1/16	3/16	26.987 ^{+0.0254}	4.762 ^{+0.051}	29.286	Wd	3 3/8	7/8	85.725 ^{+0.0381}	22.225 ^{+0.076}	95.504
Sb	1 1/8	1/4	28.575 ^{+0.0254}	6.35 ^{+0.051}	31.521	Wf	3 5/8	7/8	92.075 ^{+0.0381}	22.225 ^{+0.076}	101.955

The splines and inch bores specified are only a part of KTR's options. Many other variants are available, too.

Any questions? Please contact us.

Morskate Aandrijvingen BV

Oosterveldsingel 47A
7558 PJ Hengelo (Ov)
The Netherlands

NL

T +31 (0)74 - 760 11 11
info@morskateaanrijvingen.nl
www.morskateaanrijvingen.nl

DE

T +49 692 - 222 34 95
info@morskateantriebstechnik.de
www.morskateantriebstechnik.de

EN

T +31 (0)74 - 760 11 11
info@morskatedrivetechnology.com
www.morskatedrivetechnology.com

Morskate®



Any questions? Please contact us.

Morskate Aandrijvingen BV

Oosterveldsingel 47A
7558 PJ Hengelo (Ov)
The Netherlands

NL

T +31 (0)74 - 760 11 11
info@morskateaandrijvingen.nl
www.morskateaandrijvingen.nl

DE

T +49 692 - 222 34 95
info@morskateantriebstechnik.de
www.morskateantriebstechnik.de

EN

T +31 (0)74 - 760 11 11
info@morskatedrivetechnology.com
www.morskatedrivetechnology.com